

# Verschlusshaube mit Desmopanband

Artikelbeschreibung	
BALS-Art.-Nr	835
EAN/Stück	4024941008358
für IP 67 Stecker	16A 4pol
Schutzart (mit IP 67 Stecker)	IP67
Material Haube	Polyamid
Material Band	Desmopan
Artikelzuordnung	Zubehör
Farbe	grau RAL 7035
Gewicht	0,042 kg

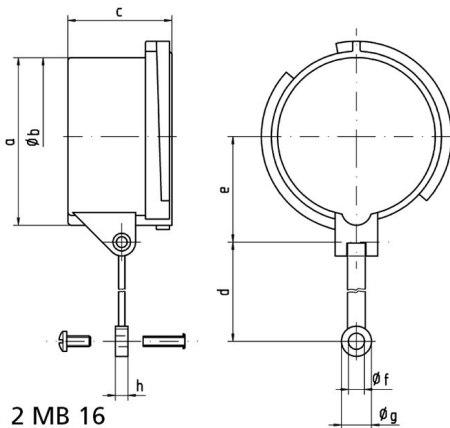

Ampere Polzahl	16 3	16 4	16 5	32 3/4	32 5	63 3/4/5	125 3/4/5
a	53,0	59,5	67,0	70,0	76,5	83,5	95,5
b ø	49,5	55,7	63,0	64,0	70,5	76,5	89,0
c	41,5	41,5	41,5	51,5	51,5	72,5	80,0
d	133,0	133,0	133,0	133,0	133,0	155,0	155,0
e	34,5	38,0	42,0	44,0	48,0	52,0	57,5
f ø	6,4	6,4	6,4	6,4	6,4	6,4	6,4
g ø	12,0	12,0	12,0	12,0	12,0	12,0	12,0
h	5,0	5,0	5,0	5,0	5,0	5,0	5,0