

Verschlusshaube mit Desmopanband

Artikelbeschreibung	
BALS-Art.-Nr	837
EAN/Stück	4024941008372
für IP 67 Stecker	32A 3pol + 4pol
Schutzart (mit IP 67 Stecker)	IP67
Material Haube	Polyamid
Material Band	Desmopan
Artikelzuordnung	Zubehör
Farbe	grau RAL 7035
Gewicht	0,061 kg

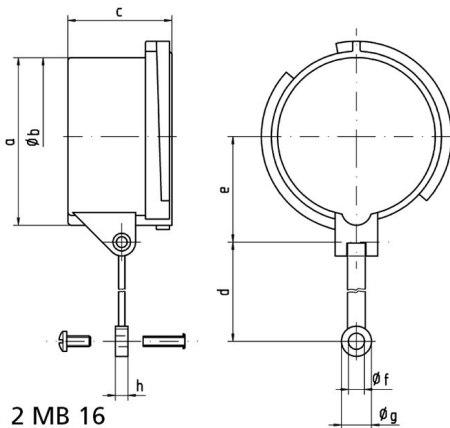

Ampere Polzahl	16 3	16 4	16 5	32 3/4	32 5	63 3/4/5	125 3/4/5
a	53,0	59,5	67,0	70,0	76,5	83,5	95,5
b ø	49,5	55,7	63,0	64,0	70,5	76,5	89,0
c	41,5	41,5	41,5	51,5	51,5	72,5	80,0
d	133,0	133,0	133,0	133,0	133,0	155,0	155,0
e	34,5	38,0	42,0	44,0	48,0	52,0	57,5
f ø	6,4	6,4	6,4	6,4	6,4	6,4	6,4
g ø	12,0	12,0	12,0	12,0	12,0	12,0	12,0
h	5,0	5,0	5,0	5,0	5,0	5,0	5,0